

USER MANUAL

PLEASE READ THE INSTRUCTIONS CAREFULLY BEFORE RIDING

VSETT-EAGLE



TFT DISPLAY



OFF - ROAD



STRONG TORQUE



HYDRAULIC BRAKE

NINGBO VSETT INTELLIGENT TECHNOLOGY CO., LTD

CONTENT

SAFETY

Safety Checklist	1-2
Safety Precautions	3

USING AND CARE YOUR E-BIKE

Bike Specification	4-7
Bike Assembly Guide	8
Assembly Instructions	8-12
Battery	13
LCD Display Settings	14
Walk Mode and Pedal-Assist	15
Set Interface	16
Riding Modes	17
Riding Limitations	18
Parking & Transport	18
Carrying Loads & Cargo	19
Safety and Care Instructions	20

MAINTENANCE

Battery Maintenance	21
Chain Maintenance	21
Front Fork Maintenance	21
Brake Maintenance	22

LIMITED WARRANTY	23-25
-------------------------------	-------

ERROR CODES

25

INCLUDED IN THE BOX

25

SAFETY CHECKLIST

Safety Check	Basic Steps
Brakes	<ul style="list-style-type: none"> • Test front and rear brakes for proper function. • Ensure brake pads are not overworn and are correctly positioned in relation to rims. • Make sure brake control cables are lubricated, correctly adjusted and display no obvious wear. • Check that brake control levers are lubricated and tightly secured to handlebars.
Wheels and Tires	<ul style="list-style-type: none"> • Inflate tires to within recommended limits displayed on sidewalls. • Check for bulges or signs of excessive wear. • Clean tires to ensure tread is exposed. • Ensure rims run true and have no obvious wobbles or kinks. • Check that all wheel spokes are tight and not broken. • Check the wheel balance in Pedal Only Mode. If you notice the riding is imbalanced or the rotation of the front wheel makes noise, it means the bolts were not completely tightened or not aligned horizontally.
Chain	<ul style="list-style-type: none"> • Check that chain is oiled, clean and runs smoothly. • Use extra care in wet or dusty conditions.
Cranks and Pedals	<ul style="list-style-type: none"> • Securely tighten pedals to cranks. • Ensure cranks are securely tightened and are not bent.
Derailleurs	<ul style="list-style-type: none"> • Check that derailleur(s) are adjusted and functioning properly. • Ensure shift and brake levers are attached to handlebar securely. • Check all brake and shift cables for proper lubrication.
Motor Drive	<ul style="list-style-type: none"> • Ensure hub motor is spinning smoothly and motor bearings are in good working order. • Check that all power cables running to hub motor are secured and undamaged. • Make sure hub motor axle bolts are secured and all torque arms and torque washers are in place.

<p style="text-align: center;">Battery and charger</p>	<ul style="list-style-type: none"> • Ensure battery is charged before use. • Check for any visible damage to battery pack. • Lock battery securely to frame. • Keep the battery away from children and pets. • Keep the battery & charger away from water and open fire. • Do not drop or subject the battery & charger to any big shocks. • Charge the battery only with the charger that was supplied with the e-bike, or the spare / replacement charger supplied by an official dealer. • Do not use the battery & charger for other purposes. • Never connect the battery's terminals with each other. • Do not cover the battery & charger or place objects on top of it during charging. • Do not leave the battery & charger unattended while charging. • Disconnect the charger and the battery immediately if you notice a strange smell or smoke. • In the unlikely case that the battery is on fire: NEVER try to put the fire out with water. Cover the fire with large amounts of sand, and call emergency services immediately.
---	---

NOTICE: When the battery has reached the end of the service life, it should be treated as hazardous waste material. It should not be disposed of in regular household trash. Ask your dealer for advice on proper disposal of the battery.

SAFETY PRECAUTIONS

The following safety notes provide additional information on the safe operation of your VSETT EAGLE and should be closely reviewed. Improper operation, or failure to confirm correct installation, compatibility, and maintenance of any component or accessory may result in serious injury or death.

BEFORE RIDING

All users must read and understand this manual before first use. Additional manuals for components used on your bicycle may be provided and should also be read before use.

Ensure you understand all instructions and safety notes/warnings.

Ensure the bike fits you properly before first use. Check local rules and regulations before riding.

It is your responsibility to familiarize yourself with the laws and requirements of operation of this product in the area(s) where you ride.

WHILE RIDING

Always wear an approved bicycle helmet whenever using this product and ensure that all helmet manufacturer instructions are used for fit and care of your helmet. Failure to wear a helmet when riding may result in serious injury or death.

Acceleration can be unexpectedly strong in pedal assist mode (Pedal Assist level 1-5), as when you pedal the motor assist will suddenly engage. Therefore, please pay careful attention when riding. We suggest you use Pedal Only Mode (Pedal Assist level 0) when you need to ride at a slow speed to cross roads, at intersections, or when pedestrian traffic is present, in order to avoid accidents caused by sudden acceleration.

Make sure you securely close the quick-release lever of the front wheel, checking the wheel balance in Pedal Only Mode. If you notice the riding feels imbalanced, or the rotation of the front wheel makes noise, it likely means the bolts were not completely tightened or didn't align horizontally in the center.

Off-road riding requires close attention and specific skills, and presents variable conditions and hazards which accompany the conditions.

Wear appropriate safety gear and do not ride alone in remote areas.

BIKE SPECIFICATION



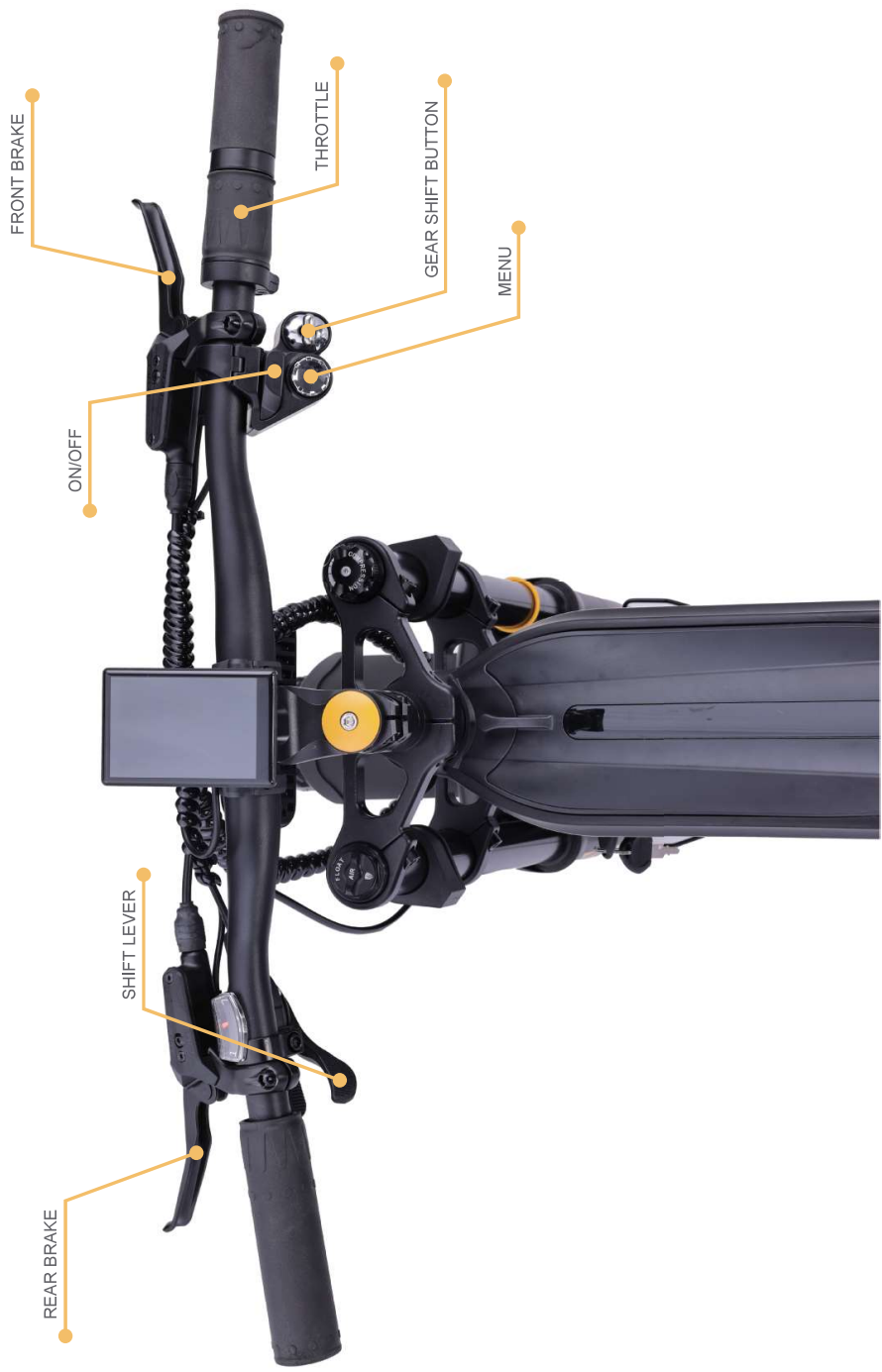

Model	VSETT-Eagle E Bike
Battery	Samsung 21700 (5000mah)
Motor	Rear Wheel 48V 500W Brushless Motors
Specification	48V 20Ah
Controllor	48V 22A
Weight	41.6KG (including the battery weight)
Charging	11HR+ (Use a standard 2A Charger)
Speed	22 km/h
Max Range	About 80km
Max loading	150kg
Open Size	1840mm×710mm×1080mm (length×width×height)
Light	12V 10W high power LED front lamp, 6V high brightness LED brake tail lamp
Front Fork	Pneumatic front fork with locking and multi-shift adjustment function

Suspension	Adjustable oil suspension (spring 800 Pounds, Compression damping 90N, Minimum recovery damping 150N Maximum recovery damping 5300N)
Chain	KMC Chain
Transmission	S-Ride 7-speed shift system
Free Wheel	S-Ride 14-28T
Drive mode	Boost mode, throttle mode
Spoke	12G
Crank	155mm aluminum alloy forging
Brake	Both oil pressure disc brake / Front and rear brakes automatically power off function Brake Disc 180MM
Tyre	20*4.0 inch Pneumatic tire / Recommended tire pressure: 30-35psi
Material	Frame: 6082-T6 special high strength aluminum alloy for aviation forging
Function	7-speed transmission, with magnetic suction storage box, wireless charging in the storage box, pneumatic front fork band locking multi-shift adjustment, shock absorption handle, headlight illumination angle adjustable

BIKE ASSEMBLY GUIDE

• Preparation Checklist



Bicycle Frame



Front Tire



Pedals

ASSEMBLY INSTRUCTIONS

1. Loosen four screws of T Bar Block cover and remove the T Bar Block cover.

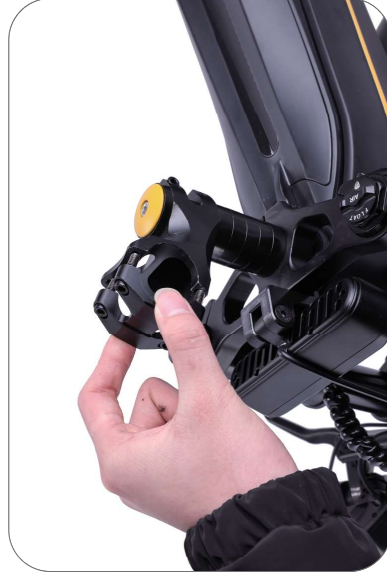

2. Put the T Bar on the Main Tube, put the harness on both sides of the headlight.

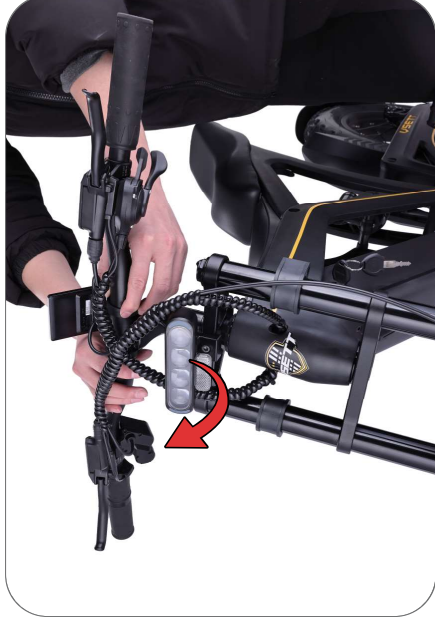

3. Install the T Bar upright cover back on the Main Tube (do not screw it completely).

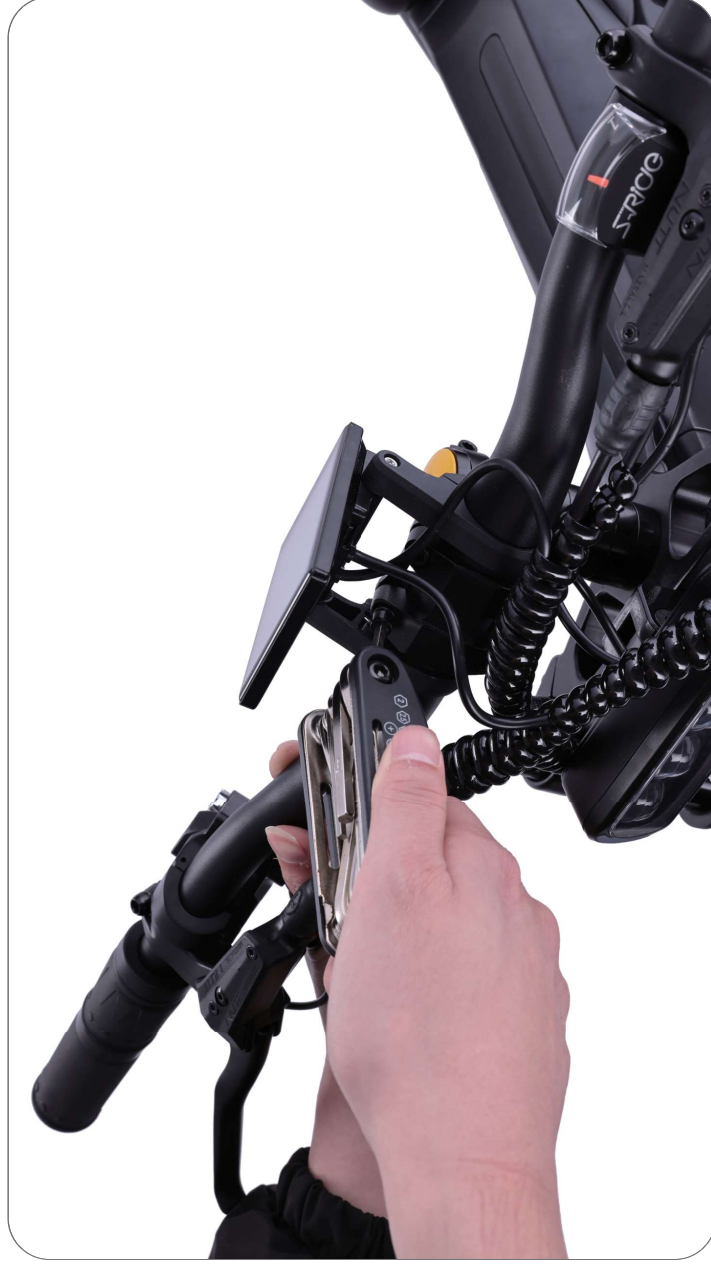

6. Ride on the bicycle, then tighten the screws.



7. Remove the front axle.

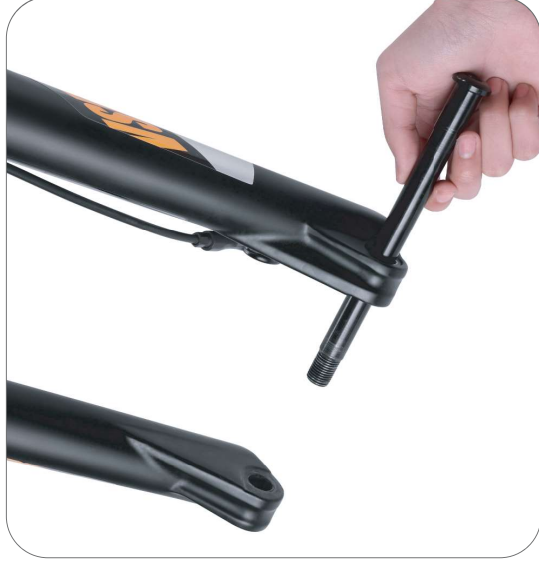

8. Put the front wheel into the gear of the front fork, and the brake disc is on the left side.



9. Pay attention to align the brake disc with the caliper.



10. Insert the front wheel shaft back into the front fork hole after the front wheel is placed in the correct position.

NOTICE: When inserting the front axle, press and hold the nut on the left to prevent it from being pushed out, and then use tools to tighten the front axle shaft.



11. Pedals Installation (15mm Wrench)

Make sure your pedals are installed on the correct side, as installing on the wrong side will damage the threads. Indicators for the right pedal (R) and the left pedal (L) can be found in a place: the bottom of the pedal threads.

Before you install the pedals, apply a small amount of waterproof grease onto the spindle. Start threading the pedal on by hand to ensure the pedal is going in perfectly straight, rotating in the direction of the pointer shown on the crank. If it is not spinning smoothly, make doubly sure that you have each pedal on the correct side. After initial hand-tightening, finish tightening the pedals with a standard 15mm wrench.



BATTERY

◆ Battery Remove

Step 1, insert the key and unlock the battery.

Step 2, turn the knob and pull the top of the battery sideways.

Step 3, lift it up to remove the battery from the bike.



◆ Mobile Wireless Charging Function

Put your phone on a circular suction cup and charge.



LCD DISPLAY SETTINGS

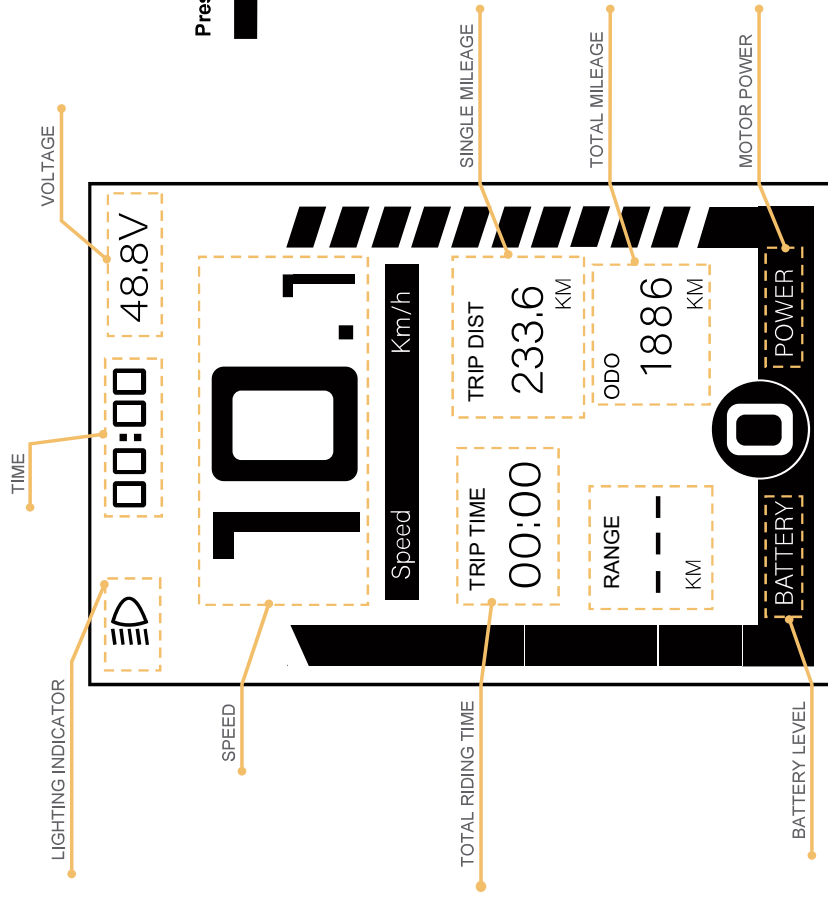

Press the menu 

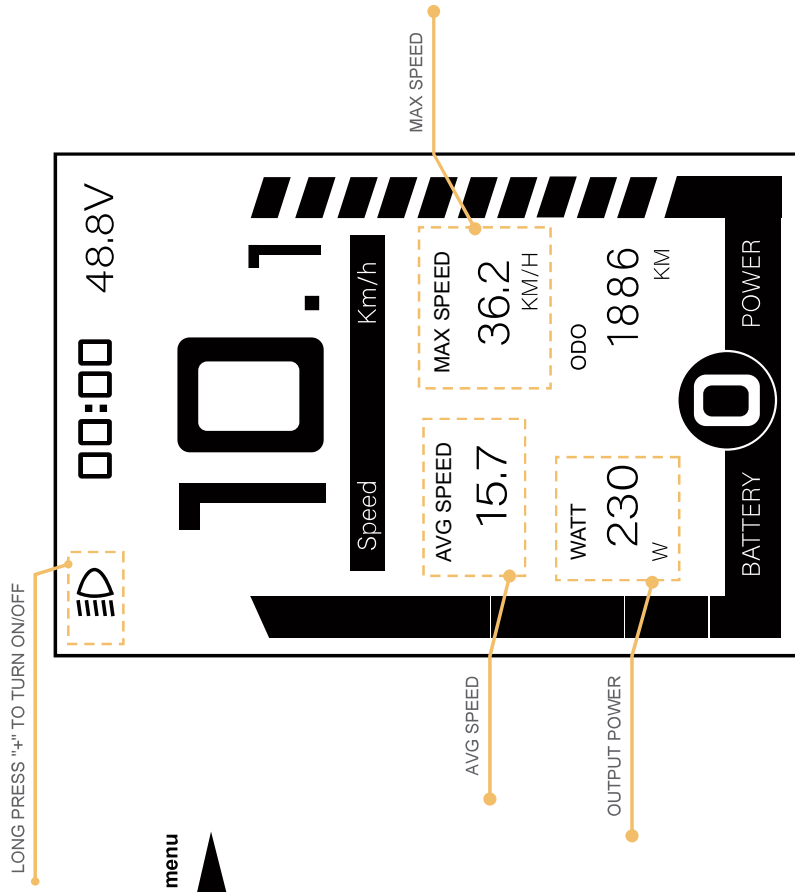

WALK MODE



Press and hold "⌋" for 2 seconds, the bicycle will provide a certain amount of assistance when pushing.

NOTICE: The special design of long press to start is to brake in time in uncontrollable situations to ensure your safety

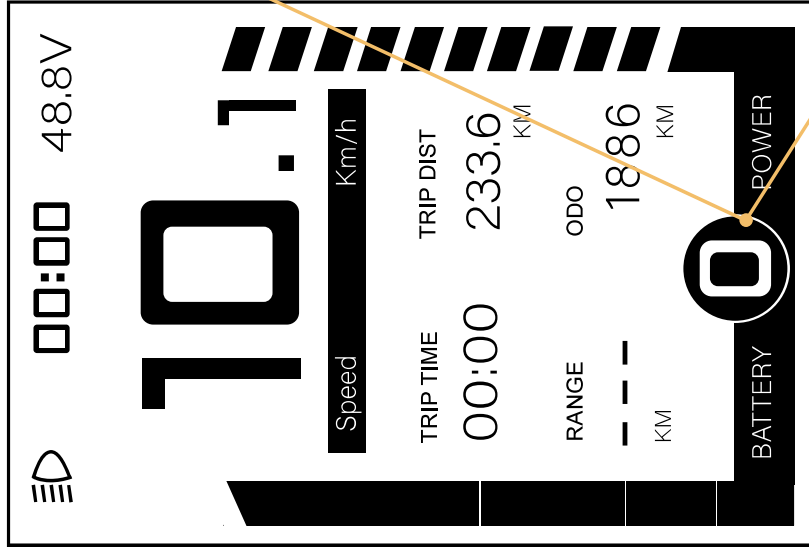

PEDAL-ASSIST

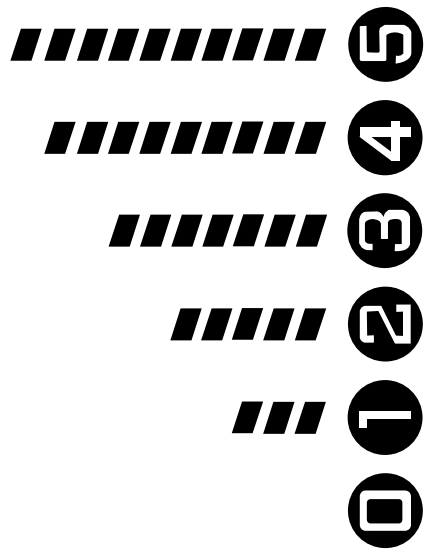









Your bike in the pedal assist mode, you can adjust the setting according to your preference. VSETT EAGLE has five pedal assist settings - ranging from 1 to 5.

NOTICE: 0 means no power, neither the auxiliary pedal nor the accelerator has power.

SET INTERFACE

- ◆ Press and hold the “M” within 10 seconds after booting to enter the user setting interface.

08:24		SET	
	EXIT		
	Model	DS103	
	Unit	KM/H	Speed unit MPH or KM/H.
	Backlight	3	1-5 levels of brightness can be selected.
	Clock	>	Set Startup Password (If you need to turn off the password, change ON to OFF, press Exit and long press the menu to save the changed settings).
	Start Password	>	
	Auto off	5 min	Optional automatic shutdown time.
	Wheel	700C	
		

RIDING MODES

◆ **Throttle-only**

The throttle mode is similar to how a motorcycle or scooter operates, alleviating the need to pedal or providing an additional boost simply by twisting the throttle.

VSETT EAGLE can reach speeds of up to 25 miles per hour with throttle mode, which not only allows you to travel faster, but also reassures riders with extra power whenever needed, depending on traffic conditions and rider energy levels. If you are an adventurer who chases after speed and distance without compromising comfort or safety, the throttle-assisted VSETT EAGLE would be your perfect companion.

◆ **Pedal-assist**

See pictures and words on page 16.

◆ **Pedal-only**

In this mode, the VSETT EAGLE will perform like a normal bike, as you'll be riding without any assistance from the motor. This mode is especially useful if you run out of battery, or are looking for more intensive resistance training.

We suggest that you select a lower assistance level when you first ride your VSETT EAGLE. After becoming more comfortable with the riding characteristics of our e-bike, and more familiar with the varying range requirements of your most common destinations and commuting routes, you can then make any needed adjustments to pedal assist settings, as well as throttle use frequency, riding position, etc.

RIDING LIMITATIONS

Following are some limitations needing riders' careful attention to ensure the mid motor does not overheat or become damaged from excessive loading:

- Do not attempt to ride up hills steeper than 15% grade.
- Use the pedals to assist the motor when climbing hills and accelerating from a stop.
- Avoid sudden starts and stops.
- Generally accelerate at a moderate pace, rather than aggressively.

PARKING & TRANSPORT

Follow these basic parking, storage, and transport tips to ensure your bike is well cared for, both on and off the road:

- When walking with the bike, turn off the power to avoid accidental acceleration.
- Though our bikes are water resistant (IPX4 Water Resistance), please do not park your bike outdoors in cold or inclement weather for extended periods.
- When parking, switch the power and any lights off to conserve battery, remove the key from the bike, and ensure the battery is secured and locked to the frame.
- In public places, help keep your VSETT EAGLE safe and secure from theft by always locking it up.
- Make sure to not park, store or transport your VSETT EAGLE on a rack that is not designed for the size and weight of the bike.

When storing or carrying your bike on a rack for transport, remove the battery to reduce the weight and make lifting or loading easier.

CARRYING LOAD&CARGO

Total Payload Capacity of VSETT EAGLE: 400 lbs Weight: 88 lbs

◆ Cargo Safe Operation Tips:

The following list provides important tips for the safe operation of the VSETT EAGLE when used for carrying cargo:

1. Make sure to load the cargo as low as possible to lower the center of gravity and improve stability.
2. Ensure your loads are properly secured and periodically check that nothing has loosened.
3. Plan your route accordingly when cargo is loaded on the VSETT EAGLE , considering hill climbing ability, steering, and braking. Also account for moderately reduced range when carrying extra cargo weight (or an additional passenger).
4. Try to get a feel for the cargo load in a flat and open private area before riding on public roads.
5. Make sure to not use the front brake by itself, with or without cargo. Always apply the rear brake first followed by the front brake. Failure of the front fork or loss of control is possible when the front brake is operated independently, especially at higher speeds.
6. The kickstand is not designed to hold the bike upright with cargo by itself, always manually hold the bike upright when loading or carrying cargo.

SAFETY AND CARE INSTRUCTIONS

To ensure safe riding conditions and maximize e-bike longevity, you must follow the guidelines outlined below:

- To clean the e-bike, wipe the frame with a damp cloth soaked in a mild, non-abrasive, non-corrosive detergent mixture. Wipe or spray all unpainted parts with anti-rust treatment after being used in coastal areas or areas with salty air or water.
- Never immerse the bike or any components in water, as the electrical system may be damaged. If the hub and bottom bracket bearings have been submerged in water, they should be removed and re-greased (this will prevent accelerated bearing deterioration).
- Periodically check wiring and connectors to ensure there is no damage, and the connections are secure.
- Store under shelter, avoiding extended exposure to cold or inclement weather. If exposed to rain or excess moisture, dry your bicycle afterward and apply anti-rust treatment to the chain and any other unpainted steel surfaces.
- Regularly clean and lubricate all moving parts, tighten components and adjust as required.
- Your cables, spokes, and chain will stretch after an initial break in period of 80-160 km, and additionally bolted connections can loosen with time and usage. Therefore, we suggest you contact a certified bicycle mechanic every two months to ensure your bike is safe and problem-free for years of use.
- If the paint has become scratched, or the metal chipped, use touch-up paint to prevent rust (clear nail polish can also be used as a preventative measure).
- Damage from corrosion is not covered under warranty, therefore special care should be given to protect and extend the life of your bike.

NOTICE:

- Snow, rain, road salts and acids can cause certain parts of the e-bike to corrode or deteriorate.
- Ultraviolet light from the sun can fade the paint and can cause rubber or plastic parts to become porous or to crack.
- Exposure to excessively high or low temperatures during storage can cause temporary malfunctions or even permanent defects

MAINTENANCE

◆ **Battery Maintenance (48V 20AH Samsung/LG Lithium-ion battery)**

1. Don't fully drain your battery. Turn off the power when the battery charge is low.
2. Fully charge the battery after each use, no matter how much power is used. This will prolong the battery life. If the battery is not used for a long time, store the battery with a full charge and charge it once a month.
3. The VSETT EAGLE can be safely ridden in light rain. However, riding through very heavy downpours or through flooded streets is not recommended, as the crank and/or motor can get wet, which may cause problems.
4. Keep the battery away from open flame or a high-temperature heat source. Do not expose the battery to direct sunlight or recharge immediately after use in high-temperature weather.

◆ **Chain Maintenance**

1. We recommend cleaning the chain after each ride, especially in rainy and humid environments. Use a dry cloth to wipe the chain and its accessories clean. Use a brush to remove sand and dirt stuck in the chain, along with use warm soapy water if needed. Do not use strong acidic or alkaline cleaning agents (such as rust remover), because these chemicals can damage the chain.
2. Apply lubricating oil after cleaning to avoid rust. First, make sure the chain is dry, and then apply the lubricating oil into the bearings.
3. To prevent unnecessary chain wear, try to maintain a vertical chain position when shifting gears (do not use the smallest gear with the smallest flywheel, or the largest gear with the largest flywheel, etc.).

◆ **Front Fork Maintenance**

1. Always use a clean, oil-free lint-free cloth with plain or soapy water to clean your bike. To prevent water from flowing into the front fork, you can turn the bike upside down. Dry with a lint-free towel after washing. Pay specific attention to the inner tube and the dust seal to reduce wear and prevent thinning of the inner tube, which can lead to significant damage if the aluminum is exposed to air.
2. We recommend using a front fork dust cover to protect the inner tube of your front fork. This prevents dust from entering as well as hard objects from hitting the inner tube.

◆ Brake Maintenance

1. Pad replacement:

Pads should be replaced if they become contaminated or have less than 2.5mm thickness. (Metal plate & wear material)

2. Before riding and After riding

Check the pads for wear or contamination.

Check the hose for cracking, wear or deformation. Replace if necessary.

Check if the brake system is operating correctly.

3. At regular intervals:

Check the oil level in the reservoir.

Lubricate the brake lever pivot with grease.

Check to make sure that all the bolts are tightened to the correct torque specifications

4. Bleed The System

You should always bleed the system after you have shortened or replaced the hose or have opened the system to the air at any time. Additionally, if the brake action feels spongy, you may improve performance by re-bleeding the system.

LIMITED WARRANTY

BY USING THIS PRODUCT YOU AGREE TO THIS LIMITED WARRANTY. PLEASE READ THIS LIMITED WARRANTY CAREFULLY.

To benefit from the limited warranty, the customer is advised to read Vsett Warranty terms together with the “care and maintenance” sections provided in the user manual. This limited warranty applies to the extent permitted by law and unless restricted or prohibited by law.

Limited Warranty Details

1. Vsett warrants that VSETT EAGLE products (“Products” or “Product”), are free from defects in material and workmanship, according to the following terms and conditions:

Electronic Accessories	Warranty Period	Basic Accessories	Warranty Period	Notes
Frame	2 years	Motor	2 years	<p>The following conditions are not covered by the warranty:</p> <p>a. Water damage of the battery, motor and controller.</p> <p>b. Battery 2-year warranty only cover the batteries that don't work in 2 years.</p> <p>c. Man-made damage, self-modification, collision damage and scratch of spare parts, etc.</p> <p>d. Tire puncture by any sharp objects.</p> <p>e. Ordinary wear and tear not resulting from defects in workmanship.</p>
Front Fork	1 year	Battery	2 years (Exclude Usable Ones)	
Handlebar	1 year	Torque Sensor	1 year	
Crank	6 months	Charger	1 year	
Throttle	6 months	LCD Screen	1 year	
Pedal	6 months	Switch	1 year	
Fly Wheel	6 months	Front Light	1 year	
Thumb Shifter	6 months			
Rear Derailleur	6 months			
Brake Disc	3 months			
Tire	3 months			

2. During the Warranty Period, Vsett or its authorized service centres will repair or replace, at Vsett's option and without costs to the customer, any defective Components with new or factory rebuilt replacement items, and return the Products to the customer in working condition, provided that the terms and conditions of this Limited Warranty are met. All defective Products or Components that have been replaced shall become the properties of Vsett.

3. Products and/or Components that have been repaired or replaced pursuant to the paragraph above will be covered by this Limited Warranty for the balance of the Warranty Period.

4. This Limited Warranty will only be effective when presented together, to either Vsett or its authorised centres, with proof of date and place of purchase of Products such as the purchase receipt.

What this Limited Warranty does not cover:

1. Products used for commercial purpose(s) including but not limited to leasing/hiring, use in competitions etc
2. Any logistical costs of returning the Product to Vsett or its authorised service centres for servicing or the cost of returning the Product to the customer after servicing.
3. Defects or damages resulting from use of the Product(s) other than its normal and customary manner as stated in the user manuals accompanying the Products.
4. Defects or damages from improper storage, exposure to moisture or dampness, modifications, connections, repairs (except as carried out by Vsett or its authorised centres), misuse, neglect, abuse, accident, alteration, improper installation, or other acts which are not the fault of Vsett, including damage caused by dropping, blown fuses, spills of food or liquid.
5. Defects or malfunctions of the product not notified by customer during the Warranty Period.
6. Products which have had their serial numbers removed or tampered with.
7. This Limited Warranty is in lieu of all other warranties, express or implied either in fact or by operations of law, statutory or otherwise, including, but not limited to any implied warranty of marketability or fitness for a particular use.

How to request service under this Limited Warranty:

To obtain performance of Vsett to repair and/or replace the Product or its Components under this Limited Warranty, the customer must, during the Warranty Period:

1. Bring this Limited Warranty, proof of purchase and the Product to Vsett.
 2. Provide Vsett with a written description of the problem.
- The average repair time is 1 to 3 days, not including shipping time to and from our service centre.

This warranty does not cover the shipping costs associated with the transportation of the scooter to and from our service centre, and a fee will be charged for return shipping or pick up and delivery service.

What can the consumer do in case of a dispute with Vsett

The consumer and Vsett agree that in the event of a dispute arising from the material and workmanship of the Product; or from this Limited Warranty, parties will attempt to first resolve the matter by negotiating in good faith.

Disclaimer:

1. The customer understands the risk of serious injury or death in the operation of such products and shall agree to take the necessary precautions and exercise good judgement to avoid hazards and dangerous situations which may result in serious injury or death.
2. The customer shall agree to indemnify and hold harmless Vsett from all injuries or death arising from the operation of the product.
3. The use of safety and protective gear such as bicycle helmets is strongly encouraged. And so is the use of Good Judgement.
4. The customer is advised to take the following precautions:
 - a. Do not ride on wet ground or in heavy rain;
 - b. Take corners slowly and look out for pedestrians;
 - c. Avoid potholes, kerbs and debris on the ground;
 - d. Keep tires pumped to the specified pressure;
 - e. Dismount in places with heavy human traffic and push the scooter manually;
 - f. Service the product every 3 months on regular usage, 6 months for non-frequent usage;
 - g. Do not use product on public roads and respect local road regulations.

ERROR CODES

ERROR CODE	FAULT STATE
06	Battery Undervoltage
07	Motor Failure
08	Throttle Failure
09	Controller Failure
10	Controller Reception Failure
11	Controller Sending Failure
14	Motor Hall Defect

INCLUDED IN THE BOX

SERIAL NUMBER	ITEM	QUANTITY
1	Bicycle Frame	1
2	Front Tire	1
3	Pedals	1 pair
4	Battery	1
5	Charger	1
6	Key	1

NEW MODELS ARE COMING SOON

 Web: www.vsett.com

 Facebook: VSETT

 Instagram: [vsett_escooters](https://www.instagram.com/vsett_escooters)

 YouTube: VSETT

 E-mail: sales@vsett-scooter.com

USER MANUAL



NINGBO VSETT INTELLIGENT TECHNOLOGY CO., LTD